WILLIAM KINGDON CLIFFORD (1845–1879)

Joe Rooney

*Department of Design and Innovation, The Open University, Walton Hall,
Milton Keynes MK7 6AA, UK
E-mail: j.rooney@open.ac.uk*

Abstract. William Kingdon Clifford was an English mathematician and philosopher who worked extensively in many branches of pure mathematics and classical mechanics. Although he died young, he left a deep and long-lasting legacy, particularly in geometry. One of the main achievements that he is remembered for is his pioneering work on integrating Hamilton's *Elements of Quaternions* with Grassmann's *Theory of Extension* into a more general coherent corpus, now referred to eponymously as Clifford algebras. These geometric algebras are utilised in engineering mechanics (especially in robotics) as well as in mathematical physics (especially in quantum mechanics) for representing spatial relationships, motions, and dynamics within systems of particles and rigid bodies. Clifford's study of geometric algebras in both Euclidean and non-Euclidean spaces led to his invention of the *biquaternion*, now used as an efficient representation for *twists* and *wrenches* in the same context as that of Ball's *Theory of Screws*.

Biographical Notes

William Kingdon Clifford was a 19th Century English mathematician and scientific philosopher who, though he lived a short life, produced major contributions in many areas of mathematics, mechanics, physics and philosophy. This he achieved during a mere fifteen-year professional career. He was the archetypal polymath, since as well as displaying remarkable mathematical skills, he was also an accomplished literature and classics scholar. Clifford was fluent in reading French, German and Spanish, as he considered these to be important for his mathematical work. He learned Greek, Arabic and Sanskrit for the challenge they presented, Egyptian hieroglyphics as an intellectual exercise, and Morse code and shorthand, because he wished to understand as many forms for communicating ideas as possible. During his lifetime Clifford was energetic and influential in championing the scientific method in



Fig. 1. A portrait of William Kingdon Clifford (1845–1879). (Source: School of Mathematics and Statistics, University of St Andrews, Scotland) (URL: <http://www-history.mcs.st-and.ac.uk/history/PictDisplay/Clifford.html>)

social and philosophical contexts, and was a leading advocate for Darwinism. He and his wife Lucy socialised regularly with many famous scientists and literary figures of the period. He even had several non-academic strings to his bow, notably gymnastics and kite flying, at which he impressed his contemporaries on numerous occasions. He was slight of build but his renowned physical strength and athletic skills no doubt came to the fore when, on a scientific expedition to Sicily (for the 22 December 1870 solar eclipse), he was shipwrecked near Catania and survived. Despite this experience he fell in love with the Mediterranean area. Sadly his health was relatively poor throughout his life and he died of pulmonary tuberculosis (then referred to as consumption) at the early age of 33 (Chisholm, 2002).

William Kingdon Clifford was born on 4th May 1845 at Exeter in the county of Devon in the south-west of England. His father (William Clifford) was a book and print seller (mainly of devotional material), an Alderman and a Justice of the Peace. His mother Fanny Clifford (née Kingdon) was the daughter of Mary-Anne Kingdon (née Bodley) who was related to Sir Thomas Bodley (1545–1613). The latter had been a lecturer in natural philosophy at Magdalen College, Oxford University during the reign of Queen Elizabeth I, and was one of the main founders of the Bodleian Library in Oxford. As a child William Kingdon lived at 9 Park Place in Exeter, the house where his mother had been born, just a short walk from 23 High Street, Exeter, where the family later moved. Exeter Civic Society has since placed a commemorative plaque on the wall of 9 Park Place, for ease of identification. Clifford

suffered early tragedy in his short life with the death of his mother in 1854, aged 35, when he was only nine. His father re-married, had four more children, and eventually died in 1878, aged 58, in Hyères, France.

On 7 April 1875 William Kingdon Clifford, aged 29, married Sophia Lucy Jane Lane, aged 28, of Camden Town, London. Lucy (her preferred appellation) claimed, romantically, to have been born in Barbados, but it seems that her only association with the island was through her grandfather John Brandford Lane, who had been a landowner there. It is unlikely that Lucy herself was ever there, and indeed there was some mystery about her background, not least because she continually lied about her age, reducing it eventually by ten years, apparently to conceal details of her past (Chisholm, 2002).

Ostensibly, William and Lucy had a happy marriage and produced two daughters. However, he was prone to overwork, lecturing and performing administrative duties during the daytime, and doing research and writing his many papers and articles at night. This probably led to a deterioration in his health, which had never been robust, and in the Spring of 1876 he accepted his poor state of health and agreed to take a leave of absence from his duties. The family then spent six months in the Mediterranean region (Algeria and Spain) while he convalesced, before returning to his academic post at University College, London in late 1876. Within eighteen months his health failed again and he travelled to the Mediterranean once more, this time returning in a feeble state in August 1878. By February 1879, with the rigours of the English winter in full force, desperate measures were required, and despite the dangers of travel in such a poor state of health William sailed with the family to the Portuguese island of Madeira in the North Atlantic Ocean to attempt to recuperate. Unfortunately he never recovered and after just a month of debilitating illness he died on 3 March 1879 at Madeira of pulmonary tuberculosis. His body was brought back to England by his wife and was buried in Highgate Cemetery in London. The following epitaph (taken from Epictetus) on his tombstone was chosen by Clifford himself on his deathbed:

I was not, and was conceived.

I loved and did a little work.

I am not, and grieve not.

Sadly the marriage had been cut short after only four years with the untimely death of William aged 33. During their four-year marriage, and subsequently as his widow, Lucy had become a successful novelist, playwright and journalist. Throughout their time together they moved in sophisticated

social circles – scientific as well as literary. After William’s death Lucy became a close friend of Henry James and regularly mixed socially with many other prominent figures including Virginia Woolf, Rudyard Kipling, George Eliot, Thomas Huxley and Thomas Hardy. Lucy outlived William by fifty years and died on 21 April 1929, aged 82. She was buried beside her husband in Highgate Cemetery. The following epitaph for Lucy was added to Clifford’s tombstone:

*Oh, two such silver currents when they join
Do glorify the banks that bound them in.*

Clifford’s formal education had begun when he gained a place at the Exeter Grammar School. However, he only spent a few months there before he transferred in 1856 to the Mansion House School, also in Exeter. This school was subsequently renamed Mr. Templeton’s Academy, and was eventually demolished by Exeter City Council after having been bombed in 1942 during World War II. In 1858 and 1859, whilst at Mr. Templeton’s Academy, Clifford took both the Oxford and the Cambridge University Local Examinations in an impressive range of subjects, gaining many distinctions. Continuing his excellent academic record, Clifford won, at age 15, a Mathematical and Classical Scholarship to join the Department of General Literature and Science at King’s College, London, and so he left Mr Templeton’s Academy in 1860. At King’s College more achievements followed when he won the Junior Mathematical Scholarship, the Junior Classical Scholarship and the Divinity Prize, all in his first year. He repeated the first two of these achievements in both his second and third years at King’s College, and additionally he won the Inglis Scholarship for English Language, together with an extra prize for the English Essay. Clifford left King’s College in October 1863, at age 18, after securing a Foundation Scholarship to Trinity College, Cambridge, to study Mathematics and Natural Philosophy. At Cambridge he continued to shine academically, winning prizes for mathematics and for a speech he presented on Sir Walter Raleigh. He was Second Wrangler in his final examinations in 1867 and gained the Second Smith’s Prize. Clifford was awarded his BA degree in Mathematics and Natural Philosophy in 1867. He completed his formal education on receiving an MA from Trinity College in 1870.

On 18 June 1866, prior to obtaining his BA, Clifford had become a member of the London Mathematical Society, which held its meetings at University College. He had served on its Council, attending all sessions in the periods 1868/69 to 1876/77. Within a year of being awarded his BA, Clifford

was elected in 1868 to a Fellowship at Trinity College. He remained at Trinity College until 1871 when he left to take up an appointment as Professor of Mathematics and Mechanics at University College, London. It appears that he had ‘lost his (Anglican Christian) faith’ and realistically could no longer remain at Trinity College. Unlike Trinity College, University College had been founded in 1827 as a strictly secular institution and the Professors were not required to swear allegiance to a religious oath. This liberal-mindedness appealed to Clifford’s freethinking viewpoint at the time, although he had been a staunch Anglican in his youth. In June 1874 Clifford was elected as a Fellow of the Royal Society, and soon afterwards he was also elected as a member of the Metaphysical Society. The latter was chiefly concerned with discussing arguments for or against the rationality of religious belief, in the prevailing intellectual climate where Darwinian evolutionary theory was at the forefront of debate. At this time he also delivered popular science lectures as well as investigating psychical research and he was instrumental in debunking spirit mediums and general claims for so-called paranormal activity.

Clearly, Clifford had wide-ranging interests, producing a considerable output of work, considering his brief life span. However, much of his academic writings were published posthumously. His academic publications fall mainly into three categories – Popular Science, Philosophy and Mathematics.

List of Main Works

A good representative example of Clifford’s *Popular Science Lectures* is “Seeing and Thinking”. His main *Philosophical Works* include the important “The Ethics of Belief” (Clifford, 1877), “Lectures and Essays”, and “The Common Sense of the Exact Sciences”. However, his *Mathematical Works*, such as “Elements of Dynamic Vol. 1”, “Elements of Dynamic Vol. 2”, and “Mathematical Papers” (Clifford, 1882), are especially interesting in the present context. In particular, the “Mathematical Papers” (edited by R. Tucker) published originally in 1882, and reprinted in 1968 (by Chelsea Publishing Company, New York), is the most relevant reference here. These mathematical papers were organised by their editor into two main groupings, namely: *Papers on Analysis*, and *Papers on Geometry*. The former analysis papers were grouped into papers on *Mathematical Logic, Theory of Equations and of Elimination, Abelian Integrals and Theta Functions, Invariants and Covariants*, and *Miscellaneous*. Although at least four papers within this

Analysis grouping are relevant in Mechanism and Machine Science, they are not of central importance. The papers in Tucker's *Geometry* grouping are the more relevant ones. Tucker organised Clifford's geometry papers into papers on *Projective and Synthetic Geometry*, *Applications of the Higher Algebra to Geometry*, *Geometrical Theory of the Transformation of Elliptic Functions*, *Kinematics*, and *Generalised Conceptions of Space*. At least sixteen papers from this *Geometry* grouping are directly related to the Mechanism and Machine Science field, but the following six are of fundamental importance:

Preliminary Sketch of Biquaternions (Clifford, 1873)

Notes on Biquaternions

Further Note on Biquaternions

On the Theory of Screws in a Space of Constant Positive Curvature

Applications of Grassmann's Extensive Algebra (Clifford, 1876a)

On the Classification of Geometric Algebras (Clifford, 1876b)

Here, only the first of these papers (on biquaternions) will be reviewed.

Review of Main Works on Mechanism and Machine Science

Preamble

Partly because of his short life, much of Clifford's academic work was published posthumously. However, his widespread network of scientific contacts, and his reputation as an outstanding teacher, together with his clear notes and instructive problems ensured that he gained the acknowledgement that he deserved during his lifetime. In the context of the history of mechanism and machine science, his papers on geometry (Clifford, 1882) are most relevant, particularly those on kinematics, and on generalised conceptions of space.

A general rigid-body spatial displacement with no fixed point can be achieved as a *twist* about a screw axis. This is a combination of a rotation about and a translation along a specific straight line (the axis) in 3D space (Ball, 1900). A similar situation arises when the rigid body undergoes continuous spatial motion, in which case, at any instant of time, it is performing a twist-velocity about a screw axis. Analogously, the most general system of forces acting on a rigid-body may be replaced with an equivalent *wrench* about a screw axis. This is a combination of a single force acting along a specific straight line (the axis) in 3D space, together with a couple, first introduced by Poinsot (1806), acting in any plane orthogonal to the line. These

scenarios may be represented algebraically in many different ways (Rooney, 1978a), but Clifford's *biquaternion* (Clifford, 1873) offers one of the most elegant and efficient representations for kinematics.

All three of Clifford's papers on biquaternions discuss and develop the concept, although the first paper, *Preliminary Sketch of Biquaternions*, is the main one that introduces the biquaternion – it is considered to be a classic and is the main one to be reviewed here. The second paper, *Notes on Biquaternions*, was found amongst Clifford's manuscripts and was probably intended as a supplement to the first paper. It is short and develops some of the detailed aspects of biquaternion algebra. The third paper, *Further Note on Biquaternions*, is more extensive and it discusses and clarifies why a biquaternion may be interpreted in essentially two different ways, either as a generalised type of number, or as an operator.

Preliminary Sketch of Biquaternions

The idea of a *biquaternion*, as presented in Clifford's three papers, *Preliminary Sketch of Biquaternions*, *Notes on Biquaternions* and *Further Note on Biquaternions* (Clifford, 1882), originated with Clifford, although the term "biquaternion" had been used earlier by Hamilton (1844, 1899, 1901). to denote a quaternion consisting of four complex number components, rather than the usual four real number components. Clifford acknowledges Hamilton's priority here but he considers that because "all scalars may be complex" Hamilton's use of the term is unnecessary. Clifford adopts the word for a different purpose, namely to denote a combination of two quaternions, algebraically combined via a new symbol, ω , defined to have the property $\omega^2 = 0$, so that a biquaternion has the form $q + \omega r$, where q and r are both quaternions in the usual (Hamiltonian) sense.

The symbol ω (and its modern version, ε) has been the focus of much misunderstanding since it is a quantity whose square is zero and yet is not itself zero, nor is it 'small'. It should be viewed as an operator or as an abstract algebraic entity, and not as a real number. Clifford confuses matters further by using the symbol in several different contexts. In Part IV (on elliptic space) of the *Preliminary Sketch of Biquaternions* paper ω has a different meaning and an apparently different multiplication rule $\omega^2 = 1$, and in the papers *Applications of Grassmann's Extensive Algebra* and *On the Classification of Geometric Algebras* there is yet another related use of the symbol ω , and this time its defining property is $\omega^2 = \pm 1$. In the early part of the *Preliminary*

Sketch of Biquaternions paper Clifford even uses ω to denote angular velocity, so there is much scope for confusion.

The classic first paper on biquaternions, *Preliminary Sketch of Biquaternions*, is organised into five sections. *Section I* introduces and discusses the occurrence of various different types of physical quantity in mechanical systems, and how they may be represented algebraically. *Section II* proceeds to construct a novel algebra, for manipulating various physical quantities, based on an extension and generalisation of Hamilton's algebra of quaternions, and this is where the term *biquaternion* is introduced. *Section III* briefly investigates non-Euclidean geometries (and specifically elliptic geometry with constant positive curvature) for the purpose of interpreting some of the projective features and properties of biquaternions. *Section IV* examines several particular physical quantities and shows that in some sense their 'ratio' is a biquaternion. Finally *Section V* looks at five specific geometrical scenarios involving biquaternions. The short second paper of the trio, *Notes on Biquaternions*, appears to continue this latter Section V with a further two geometrical scenarios.

Clifford's motivation in creating his biquaternion derives essentially from mechanics, and in Section I of *Preliminary Sketch of Biquaternions* he draws attention to the inadequacies of algebraic constructs such as scalars and vectors for representing some important mechanical quantities and behaviours. Many physical quantities, such as energy, are adequately represented by a single magnitude or *scalar*. But he states that other quantities, such as the translation of a rigid body, where the translation is not associated with any particular position, require a magnitude and a direction for their specification. Another example is that of a couple acting on a rigid body, where again a magnitude and direction are required but the position of the couple is not significant. The magnitude and direction of either a translation or of a couple may be represented faithfully by a *vector*, as Hamilton had shown.

However, Clifford emphasises that there are several mechanical quantities whose *positions* are significant, as well as their magnitudes and directions. Examples include a rotational velocity of a rigid body about a definite axis, and a force acting on a rigid body along a definite line of action. These cannot be represented adequately just by a vector, and Clifford introduces the term *rotor* (probably a contraction of 'rotation vector') for these quantities, that have a magnitude, a direction and a position constrained to lie along a straight line or axis.

In order to combine or to compare scalar, vector and rotor quantities, some form of consistent algebra is desirable that faithfully represents the required processes of combination/comparison. Scalar quantities may be dealt with using the familiar real number algebra. Its standard operations of addition, subtraction, multiplication and division usually yield intuitively plausible results for the magnitudes of scalars.

For vectors in a 2D space the complex numbers (considered as 2D vectors), offer something fundamentally new in that they can be used to represent and compare directions as well as magnitudes, by forming the ratio of two complex numbers and hence by using the complex number division operation. Moreover, complex numbers may be used as operators for rotating and scaling geometrical objects in a 2D space.

In the case of vector quantities in 3D space, consistent addition and subtraction operations may be defined using “vector polygons” to combine vectors (denoted by straight line segments) in a way that takes account of their directions. The standard approach is based on empirical knowledge of how two translations (or two couples) behave in combination. So, two vectors may be added (subtracted) to give a meaningful sum (difference), which is itself another vector. But if an attempt is made to *compare* two vectors, in the way that two scalars might be compared, by forming their ratio using algebraic division, there is a problem.

In 3D space Hamilton (1844, 1899, 1901) had shown that it is difficult to define any form of division operation to obtain the ratio of two vectors because such a ratio could not itself be a vector. He had demonstrated conclusively that forming the ‘ratio’ of two 3D vectors requires the specification of four independent scalar quantities, and so the outcome must be a 4D object in general. He had also shown that two different vector ‘ratios’ are obtained from ‘left-division’ and ‘right-division’ (left- and right-multiplication by an inverse), and so the operation is non-commutative. Hamilton had solved the problem by inventing quaternions and their consistent non-commutative (4D) algebra. A 3D vector algebra cannot be closed under multiplication and ‘division’, despite the fact that it is closed under addition and subtraction. Instead the 3D vectors must be embedded in a 4D space and treated as special cases of 4D vectors with one zero component. Hamilton’s algebra was based on a *quaternion product* that could be partitioned into a *scalar* part and a *vector* part. These parts were subsequently treated separately by Gibbs as a ‘*dot*’

product and a ‘*cross product*’ to form the basis of his later vector algebra (Gibbs, 1901).

Clifford extends Hamilton’s approach and investigates the situation with rotors, which are even more problematical than 3D vectors. In this case empirical knowledge and experience demonstrate that the combination of two rotational velocities with different (skew) axes does not produce a rotational velocity. Instead it produces a general rigid-body motion. In a similar way the combination of two forces with different (skew) lines of action does not produce another force with a definite line of action. Instead it produces a general system of forces (Ball, 1900). So, an algebra for rotors in 3D space cannot be expected to be closed under addition or subtraction, and by analogy with the situation with 3D vectors neither can it be expected to be closed under multiplication or division. Clifford tackles the problem by proceeding to develop a consistent approach that can deal comprehensively with scalars, vectors and rotors, together with their combinations under suitably defined operations of addition, subtraction, multiplication and division. His aim is to provide an algebra for an extended range of physical quantities in mechanics.

As a first step Clifford refers to Ball’s work on screw theory (Ball, 1900) which he acknowledges as a complete exposition of general velocities of rigid bodies and of general systems of forces on rigid bodies. Ball had shown that the most general velocity of a rigid body is equivalent to a rotation velocity, about a definite axis, combined with a translation velocity along this axis, thus forming a helical motion, which he referred to as a *twist* velocity about a screw. The screw consists of a screw axis (the same line as the rotation axis) together with a *pitch* (a linear magnitude) given by the ratio of the magnitude of the translational velocity to the magnitude of the rotational velocity. The twist velocity is hence a screw with an associated (angular speed) magnitude.

Analogously Ball had also shown that the most general system of forces on a rigid body is equivalent to a single force with a definite line of action, combined with a couple in a plane orthogonal to this axis, thus forming a helical force system that he referred to as a *wrench* about a screw. In this case the screw consists of a screw axis (the same line as the line of action of the single force) together with a *pitch* (a linear magnitude) given by the ratio of the magnitude of the couple to the magnitude of the single force. The wrench is hence a screw with an associated (force) magnitude.

Clifford completes Section I of the paper by introducing the term *motor* (probably a contraction of ‘motion vector’) to denote this concept of a (force

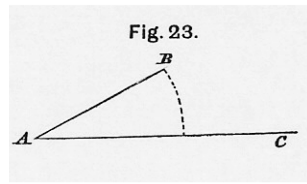

Fig. 2. The ratio of two vectors. (Source: W.K. Clifford, 1882, Collected Papers, facing p. 228, Chelsea Publishing Company, New York)

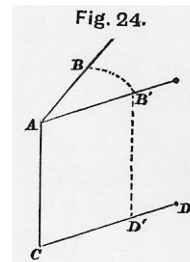

Fig. 3. The ratio of two rotors. (Source: W.K. Clifford, 1882, Collected Papers, facing p. 228, Chelsea Publishing Company, New York)

or angular speed) magnitude associated with a screw. He thus designates the sum of two or more rotors (representing forces or rotation-velocities) as a new object, namely a motor, and then establishes that although the addition of rotors is not closed, the addition of motors is closed. By considering any vector and any rotor to be degenerate forms of motor, and noting that the sum of two motors is always a motor, Clifford effectively achieves an algebra of vectors, rotors and motors that is closed under addition and subtraction.

In Section II of *Preliminary Sketch of Biquaternions* Clifford proceeds to develop further his algebra of motors by examining whether or not he can define their multiplication and ‘division’. He begins by noting that Hamilton’s quaternion may be interpreted either as the ratio of two 3D vectors, or as the operation which transforms one of the vectors into the other. He illustrates this with a figure (Figure 2) showing two line segments, labelled AB and AC , to represent the two vectors. These have different lengths (magnitudes) and directions, and although the vectors have arbitrary positions, the line segments are positioned conveniently so that they both emanate from the same point, A . He explains that AB may be converted into AC by rotating it around a rotation axis through A that is perpendicular to the plane BAC , until AB has the same direction as AC , and then stretching or shrinking its length until it coincides with AC . The process of combining the rotation with the magnification may be thought of as taking the ratio of AC to AB , or alternatively as operating on AB to produce AC . Hamilton had previously shown this process to be representable as a quaternion q . It may be written either in the form of a ratio $AC/AB = q$ or in the form of an operation $q \cdot AB = AC$. If the magnification is ignored, the rotation by itself essentially represents the ratio

of two directions, namely those of AC and AB , or, equivalently, the process of transforming one direction into the other.

Clifford states that this particular quaternion q will operate on any other vector AD in the plane BAC in the same way, so that another such vector AD will be rotated about the same axis perpendicular to the plane BAC through the same angle, and be magnified in length by the same factor to become AE in the plane BAC , where angle DAE equals angle BAC . However, he also states that this quaternion q operating on any vector, say AF , not lying in the plane BAC does not rotate and magnify AF in this way. In fact he gives no meaning to this operation. So, a quaternion formed from the ratio of the two vectors AB and AC can operate only on vectors in the plane BAC .

By analogy with Hamilton's quaternion, used for the ratio of two 3D vectors, Clifford considers forming the ratio of two rotors. He describes how two rotors (with different (skew) axes) may be converted one into the other. Again he uses a diagram (Figure 3) to illustrate the procedure. The two rotors are represented as two line segments lying along (skew) axes, and labelled AB and CD . These have different lengths (magnitudes), directions and positions, but they are partially constrained in position to always lie somewhere along their respective axes. He states that there is a unique straight line that meets both rotor axes at right angles, and he positions the line segments so that the points A and C lie on this unique line. The length of the line segment AC then represents the shortest distance between the two rotor axes. Clifford outlines how the rotor AB may be converted into the rotor CD , in three steps. Firstly, rotate AB about the axis AC into a position AB' , which is parallel to CD . Secondly, translate AB' along AC , keeping it parallel to itself, into the position CD' . Thirdly, stretch or shrink the length of CD' until it coincides with CD . The combination of the first two operations is clearly seen to be a twist about the screw with axis AC with pitch given by length $AC/\text{angle } BAB'$. The third operation is simply a magnification (a scale factor). So, Clifford demonstrates that the ratio of the two given rotors AB and CD is a twist about a screw combined with a (real number) scale factor. He writes this ratio in the form $CD/AB = t$ or alternatively as an operation in the form $t \cdot AB = CD$, and he refers to t as a *tensor-twist* (the word "tensor" in the sense that he uses it here is not related to the modern use of the word). If the scale factor is ignored, the twist about the screw by itself essentially represents the ratio of two (skew) axes, namely those of CD and AB , or, equivalently, the process of transforming one axis into the other.

Clifford states that this particular tensor-twist t (the ratio of the two rotors AB and CD) will operate on any other rotor EF whose axis meets the axis of t (that is the axis of AC) at right angles. It will rotate EF about the axis of AC through an angle BAB' , translate it along this axis through a distance equal to the length of AC , and stretch or shrink its length in the ratio of the lengths of CD to AB . However, Clifford also states that t operating on any rotor, say GH , that does not meet the axis of AC , or that does not meet it at right angles, will not rotate, translate and magnify GH in this way. In this case he gives no meaning to the operation. So, a ratio of two rotors AB and CD can operate only on other rotors whose axes intersect their screw axis orthogonally.

At this stage the ratio of two vectors has been considered (following Hamilton) and the ratio of two rotors has been derived. Clifford now investigates the ratio of two motors. He first looks at a special case, namely that where the two motors have the same pitch. He shows that in this case the ratio of these two motors is again a tensor-twist. His proof relies on expressing each of the motors as the sum (actually he uses a linear combination) of two rotors (he had stated earlier that the sum of two rotors is a motor). Clifford considers the first motor to be a linear combination of two rotors α and β , so the first motor is $m\alpha + n\beta$, where m and n are real scale factors (scalars). Then he considers a tensor-twist t whose axis intersects both of the axes of α and β at right angles (hence the axis of t lies along the common perpendicular of the axes of α and β). The effect of t on the rotor α is to produce a new rotor $\gamma = t\alpha$, and similarly t acting on the rotor β produces another new rotor $\delta = t\beta$. He now forms a second motor, this time from a linear combination of the two new rotors γ and δ , by using the same scale factors m and n as he used in constructing the first motor, giving the second motor as $m\gamma + n\delta$. This ensures that the second motor has the same pitch as the first motor. Finally, he assumes that the distributive law is valid for rotors and constructs the following sequence: $t(m\alpha + n\beta) = m(t\alpha) + n(t\beta) = m\gamma + n\delta$. Hence he shows that:

$$t = \frac{m\gamma + n\delta}{m\alpha + n\beta}$$

is the ratio of the two motors having the same pitch.

This establishes that the ratio of two motors with the same pitch is again a tensor-twist. Unfortunately, if the motors do not have the same pitch, their ratio is not a tensor-twist, and so Clifford then sets out to derive the general case. The procedure is quite lengthy and involves the introduction of a new

operator ω with a somewhat counter-intuitive property, namely $\omega^2 = 0$. In modern times this symbol has been changed to ε , partly to avoid confusion with the commonly used symbol for rotational speed, and partly to suggest pragmatically that it is akin to a small quantity whose square may be neglected in algebraic calculations and expansions. It is now referred to as a *dual number*, or more specifically as the *dual unit*.

Clifford considers that the ratio of two general motors will be established if a geometrical operation can be found that converts one motor, say A , into another motor, say B . He begins his analysis of the general case by observing that every motor can be decomposed into the sum of a rotor part and a vector part, and that the pitch of the motor is given by the ratio of the magnitudes of the vector and rotor parts. This is justified empirically by remembering that a wrench (an example of a motor) consists of the sum of a force with its line of action (a rotor), and a couple in a plane orthogonal to the line of action (a vector). Another example is a twist velocity (a motor) consisting of the sum of a rotational velocity about an axis (a rotor), and a translational velocity along the axis (a vector). Clifford states that, because of this generally available decomposition of any motor into a rotor plus a vector, it is possible to change arbitrarily the pitch of the motor without changing the rotor part, by combining the motor with some other suitable vector. So, to convert a given general motor A into another given general motor B , he proceeds by introducing an auxiliary motor B' that has the same rotor part as B but that has the same pitch as A . He has already shown that the ratio of two motors with the same pitch is a tensor-twist, so he immediately knows the ratio $B'/A = t$. He expresses B' in terms of B by adding an appropriate vector, $-\beta$, so that: $B = B' + \beta$ where β is a vector parallel to the axis of B .

Clifford can then write the ratio of B to A as:

$$\frac{B}{A} = \frac{B'}{A} + \frac{\beta}{A} = t + \frac{\beta}{A}.$$

This is the sum of a tensor-twist t with a new object β/A . The latter is the ratio of a vector in some direction, to a motor with an axis generally in a different direction, and as yet its nature is unknown. He proceeds to investigate the nature of this new ratio by introducing a symbol ω to represent an operator that converts any motor into a vector parallel to the axis of the motor and of magnitude equal to the magnitude of the rotor part of the motor. Thus, for example, ω converts rotation about any axis into translation parallel to that axis. Similarly, ω converts a force along its line of action into a couple in a

plane orthogonal to that line of action. By definition ω operates on a motor, and the effect of ω operating on a vector such as a translation or a couple is to reduce these to zero. So, ω operating on a motor, produces a (free) vector from its rotor part and simultaneously eliminates the vector part of the motor. Thus, operating with ω twice in succession on any motor A always reduces the motor to zero, that is $\omega^2 A = 0$, or expressed simply, in more modern form, $\omega^2 = 0$.

Clifford states the above operation algebraically as $\omega A = \alpha$, where A is a general motor and α is the (free) vector with the same direction and magnitude as the rotor part of A . He recalls that the ratio of two vectors is a quaternion and hence $\beta/\alpha = q$ is a quaternion, so $\beta = q\alpha$. This allows him to write the following sequence: $\beta = q\alpha = q\omega A$, so that: $\beta/A = q\omega$, and therefore: $B/A = t + q\omega$.

The latter expresses the ratio of two general motors A and B as the sum of two parts, namely a tensor-twist t and a quaternion q multiplied by ω . At this stage Clifford has derived a clear interpretation for the ratio of two motors but he is not content with this form. He proceeds to interpret the ratio B/A differently and eventually expresses it in an alternative interesting form.

His alternative interpretation requires some further analysis, but it leads to a more sophisticated result involving the new concept of a *biquaternion*. He starts by considering an arbitrary point, O , in space as an origin. From empirical knowledge of forces, couples, rotational and translational velocities, he is able to state that, in general, any motor may be specified uniquely as the sum of a rotor with axis through the origin, O , and a (free) vector, with a different direction from that of the rotor. He proceeds to observe that rotors whose axes always pass through the same fixed point behave in exactly the same way as (free) vectors. The ratio of any two of these rotors is of course a tensor-twist, because both have the same (zero) pitch. But the pitch of this tensor-twist is zero because the rotor axes intersect (in modern terms there is no translation along a common perpendicular line), and so the ratio of the two rotors through the same fixed point is essentially a quaternion with axis constrained to pass through the fixed point.

At this stage Clifford's notation becomes slightly confusing. Now he chooses to use a cursive Greek letter to represent a rotor whose axis passes through the origin, and the same cursive Greek letter prefixed by the symbol ω to represent a vector with the same magnitude and direction as the corresponding rotor. So, the rotor α whose axis passes through the origin, and the

vector $\omega\alpha$ are parallel in direction and they have the same magnitude. This does make sense because, as stated earlier, the effect of ω operating on any motor, including the zero-pitch motor α (a rotor) with axis through the origin, is to convert it into a vector in just this way. Clifford writes (à la Hamilton) the ratio of two such vectors $\omega\alpha$ and $\omega\beta$ as a quaternion $p = \omega\beta/\omega\alpha$ and by ‘cancelling’ the ω this becomes $p = \beta/\alpha$ where α and β are rotors with axes through the origin. [Clifford uses the letter q , rather than p , as a general symbol for a quaternion, but the letter p has been substituted here instead to distinguish it as a different quaternion from the one to be introduced below.] So, in this way he has shown that the quaternion p represents either the ratio of two vectors $\omega\alpha$ and $\omega\beta$, or, equivalently, the ratio of two respectively parallel rotors α and β with axes passing through the origin.

Clifford is now able to state the general expression for a motor as $\alpha + \omega\beta$. This agrees with empirical evidence since it is the sum of a rotor α , with axis through the origin, and a (free) vector $\omega\beta$, with a direction that differs, in general, from the direction of α . The ratio of two such general motors, $\alpha + \omega\beta$ and $\gamma + \omega\delta$, is the algebraic expression:

$$\frac{\gamma + \omega\delta}{\alpha + \omega\beta}.$$

To evaluate this, Clifford continues by recognising that the ratio of the two rotors α and γ , with axes through the origin, is some quaternion, $\gamma/\alpha = q$. From this he has that $q\alpha = \gamma$, and so $q(\alpha + \omega\beta) = q\alpha + q\omega\beta = \gamma + \omega q\beta$. But now he has to determine the geometrical nature of the algebraic product $q\beta$ in this expression. Operating on α with q clearly rotates it into γ , but since β does not in general lie in the same plane as α and γ , the geometrical effect of operating on β with q is not yet known, although algebraically it is just another quaternion.

Clifford tackles this problem of geometrical interpretation by introducing yet another quaternion r and using the algebra of quaternions to derive, in the first instance, some formal algebraic expressions. Since any algebraic combination of quaternions, vectors (equivalent to quaternions with zero first component) and rotors through a fixed point (equivalent to vectors) is a quaternion, he defines r as the quaternion,

$$r = \frac{\delta - q\beta}{\alpha},$$

from which he has: $r\alpha = \delta - q\beta$. He then operates on this with ω and obtains $\omega r\alpha = \omega\delta - \omega q\beta$. Finally, he adds this equation to the earlier one

$q(\alpha + \omega\beta) = \gamma + \omega q\beta$, to derive the following expression:

$$(q + \omega r)(\alpha + \omega\beta) = \gamma + \omega\delta,$$

in which the defining property $\omega^2 = 0$ is used. Re-writing the final expression in the form:

$$\frac{\gamma + \omega\delta}{\alpha + \omega\beta} = q + \omega r$$

shows that the ratio of two general motors is the sum of two terms. The first is a quaternion and the second is a quaternion operated on by ω . Clifford refers to this new quantity, representing the ratio of two general motors, as a *biquaternion*. Unfortunately, he then states that this biquaternion has no immediate interpretation as an operator in the way that a quaternion operates on a vector to give another vector (if the first vector is orthogonal to the axis of the quaternion). This conclusion is somewhat unsatisfactory but in the remaining Sections III–V of the paper *Preliminary Sketch of Biquaternions* he addresses the shortcoming by setting the biquaternion concept in the wider context of projective geometry. He ends the section with the following Table 1, summarising his perception of the situation so far.

Table 1. Summary of geometrical forms and their representations. (Source: W.K. Clifford, 1882, *Collected Papers*, p. 188, Chelsea Publishing Company, New York)

GEOMETRICAL FORM	QUANTITY	EXAMPLE	RATIO
Sense on st. line	Vector on st. line	Addition or Subtraction	Signed Ratio
Direction in plane	Vector in plane	Complex quantity	Complex Ratio
Direction in space	Vector in space	Translation, Couple	Quaternion
Axis	Rotor	Rotation-Velocity, Force	Twist
Screw	Motor	Twist-Velocity, System of Forces	Biquaternion

In Section III of *Preliminary Sketch of Biquaternions*, Clifford amplifies the concept of the biquaternion in the context of non-Euclidean spaces, particularly the elliptic geometry of constant positive curvature. This is a generalisation into 3D (curved space) of the 2D geometry of the (curved) surface of a sphere. Using the formalism of projective geometry he outlines the following facts, relating to this elliptic (constant positive curvature) non-Euclidean space:

- Every point has a unique set of three coordinates, and conversely every set of three coordinate values defines a unique point;
- There is a quadric surface, referred to as the *Absolute*, for which all its points and tangent planes are imaginary;
- Two points are referred to as *conjugate* points, with respect to the absolute, if their ‘distance’ (an angle) apart is a quadrant, and two lines or two planes are conjugate if they are at right angles to each other;
- In general, two lines can be drawn so that each meets two given lines at right angles, and the former are referred to as *polars* of each other;
- A twist-velocity of a rigid body has two axes associated with it because translation along one axis is equivalent to rotation about its polar axis and vice versa;
- A twist-velocity of a rigid body has a unique representation as a combination of two rotation-velocities about two polar axes;
- The motion of a rigid body may be expressed in two ways, either as a twist-velocity about a screw axis with a certain pitch, or as a twist-velocity about the polar screw axis with the reciprocal of the first pitch;
- In general, a motor may be expressed uniquely as the sum of two polar rotors;
- A special type of motor arises when the magnitude of the two polar rotors are equal, because the axes of the motor are then indeterminate, so that the motor behaves as a (free) vector;
- There are *right vectors* and *left vectors* in elliptic space, depending on the handedness of the twist of the motor from which they are derived, whose axes are indeterminate;
- In elliptic space if a rigid body rotates about an axis through a certain ‘distance’ and simultaneously translates along it through an equal ‘distance’, then all points of the body travel along ‘parallel straight lines’ and the motion is effectively a rotation about any one of these lines together with an ‘equal’ translation along it.

From these facts Clifford derives the following proposition at the end of Section III:

Every motor is the sum of a right and a left vector.

This he expresses in the form

$$A = \frac{1}{2}(A + A') + \frac{1}{2}(A - A'),$$

where A is the motor and A' is its polar motor, and where $(A + A')$ and $(A - A')$ are both motors of pitch unity, but one is right-handed and the other is left-handed.

In Section IV of *Preliminary Sketch of Biquaternions*, Clifford continues with his treatment of motors in the context of elliptic geometry and essentially sets up a coordinate system for rotors passing through the origin. He bases this on the three mutually perpendicular unit rotors i , j , and k whose axes are concurrent at the origin. Any rotor through the origin then has the form $ix + jy + kz$, where x , y , and z are scalar quantities (ratios of magnitudes). He gives another interpretation to i , j , and k as operators. Thus for instance i operates on any rotor that intersects the axis of i at right angles and rotates it about the axis of i through a right angle. Similar comments apply to j and k , and their axes. Clifford refers to these operations as *rectangular rotations*. Performing repeated rectangular rotations leads to the familiar quaternion equations $i^2 = j^2 = k^2 = ijk = -1$ and hence Clifford interprets the unit quaternions i , j and k as rectangular rotations about the coordinate axes. He states that for operations on rotors which are orthogonal to, but do not necessarily intersect, the axes of i , j , and k , the quaternion equations are still valid.

The rotor $ix + jy + kz$ is interpreted as a rectangular rotation about the axis of the rotor, combined with a scale factor $(x^2 + y^2 + z^2)^{1/2}$. It operates only on those rotors whose axes intersect its axis at right angles. The remainder of Section IV explores various consequences of these interpretations and concludes with another proof that the ratio of two motors is a biquaternion, as defined in Section II.

The final Section V of *Preliminary Sketch of Biquaternions*, is short and deals with some applications of the rotor concept in elliptic geometry looking at special cases of geometrical interest. There are five sub-sections as follows: Position-Rotor of a point; Equation of a Straight Line; Rotor along Straight Line whose Equation is given; Rotor ab joining Points whose Position-Rotors are α , β ; Rotor parallel to β through Point whose Position-Rotor is α . These are not reviewed here since they are not of central interest to the field of Mechanism and Machine Science.

Modern Interpretation of Contributions to Mechanism and Machine Science

Preamble

Since the time of Clifford's seminal papers on biquaternions considerable progress has been made in this topic. The theoretical aspects have been significantly advanced by mathematicians developing new types of 'number', such as dual numbers and double numbers (Dickson, 1923, 1930; Yaglom, 1968), and new fields in abstract algebra such as the eponymous Clifford algebras (Grassmann, 1844; Clifford, 1876a, 1876b; Altmann, 1986; Hestenes and Sobczyk, 1987; Conway and Smith, 2003; Rooney and Taney, 2003; Rooney 2007). In the realm of applications, major progress has been made in mechanics (particularly in kinematics) using various dual quantities and or motors (Denavit, 1958; Keler, 1958; Yang, 1963, 1969; Yang and Freudenstein, 1964; Dimentberg, 1965; Yuan, 1970, 1971; Rooney, 1974, 1975b), and many other leading researchers in mechanics refer to quaternions and biquaternions in dealing with screw theory, notably (Hunt, 1978; Davidson and Hunt, 2004). In physics also (and particularly in quantum mechanics) various types of Clifford algebras are in use (Hestenes, 1986; Penrose, 2004). Furthermore, other related application areas have used or could profitably use the quaternion concept (Rogers and Adams, 1976; Kuipers, 1999) and could benefit from a generalisation to the biquaternion. However, it must be said that Clifford's inventions have not had universal acceptance, and, as noted by Baker and Wohlhart (1996), one early researcher in particular (von Mises, 1924a, 1924b) deliberately set out to establish an approach to the analysis of motors that did not require Clifford's operator ω .

Clifford's important achievements are numerous and wide-ranging, but in the present context the more significant ones include: the invention of the operator ω ; the clarification of the relationship between (flat) spatial geometry and (curved) spherical geometry; the derivation of the biquaternion concept; and the unification of geometric algebras into a scheme now referred to as Clifford algebras. But before considering these in more detail from a modern viewpoint it is worth drawing attention to some problematical aspects.

Despite the elegance of Clifford's work on biquaternions, there are several subtleties that must be considered in the context of mechanics. The immediate problem, apparent from the outset is that a biquaternion, defined originally by Clifford as a ratio of two motors, does not appear to be interpretable as an

operator that generally transforms motors, one into another. Actually it can be interpreted in a restricted sense in this way provided that it operates only on motors whose axes intersect the axis of the biquaternion orthogonally. This is analogous to the situation with Hamilton's quaternion and rotations. However, these difficulties are resolved by forming a triple product operation, involving three terms, rather than the one used initially by Clifford, involving just two terms, and by *not* interpreting the quaternion units i , j , and k as rotations through a right angle about the x , y , and z axes, respectively, as is commonly done (Porteous, 1969; Rooney, 1978a; Altmann, 1989). This new three-term biquaternion operation allows any motor to be screw displaced into another position and orientation and not just those motors whose axes are orthogonal to and intersect the biquaternion axis. By way of comparison the equivalent operation for quaternions rotates any vector and not just those orthogonal to the axis of the quaternion (Brand, 1947; Rooney, 1977; Hestenes, 1986).

A second problem arising from Clifford's work on biquaternions relates to the use in dynamics of his operator ω , with the property $\omega^2 = 0$. Since its introduction it has taken on a wider life of its own and is now studied (independently of its roots in mechanics) as an abstract algebraic entity (Dickson, 1923, 1930). Currently, it is referred to as a *dual number*, and is designated by the symbol ε , where $\varepsilon^2 = 0$ (Yaglom, 1968). It was introduced, essentially in the contexts of geometry, statics and kinematics and has been employed very successfully there. In the realm of mechanics in general it has spawned a range of dual-number and other dual-quantity techniques applicable in the analysis and synthesis of mechanisms, machines and robots (Denavit, 1958; Keler, 1958; Yang, 1963, 1969; Yang and Freudenstein, 1964; Dimentberg, 1965; Yuan, 1970, 1971; Rooney, 1974, 1975b). However, although these techniques generally work well in geometry, statics and kinematics, where spatial relationships, rotational velocities, forces and torques are the focus, they are often of more limited use in dynamics, where accelerations, and inertias are additionally involved. Here again there is some difficulty of interpretation but perhaps more importantly the algebraic structure of the dual number and other dual quantities do not appear properly to represent the nature of the underlying dynamical structures (von Mises, 1924a,b; Kislitzin, 1938; Shoham and Brodsky, 1993; Baker and Wohlhart, 1996).

Dual Numbers, Dual Angles, Dual Vectors and Unit Dual Quaternions

When considering the geometry or motion of objects in 3D space the most common transformations in use are those that operate on points. These are referred to as *point transformations* and the familiar 4×4 real matrix, operating on the homogeneous coordinates of any point, falls into this class (Maxwell, 1951; Rooney, 1977). However, the modern use of Clifford's operator ω and his biquaternion, together with quantities derived from them, essentially rests on a consideration of 3D space as a collection of (straight) lines as well as points, because lines occur (as rotation and screw axes) in any discussion of motion and the forces that cause motion. A line has four degrees of freedom of position and orientation and requires four independent coordinates for its specification (Semple and Roth, 1949), whereas a point needs only three coordinates. The transformations required for lines are naturally referred to as *line transformations*. One type of representation of lines, and also of transformations of lines, involves dual numbers (the modern version of Clifford's operator ω). Lines may be represented using dual vectors, whereas transformations are represented using dual quaternions (the modern version of Clifford's biquaternions).

It has proved convenient to use six so-called Plücker coordinates in the mathematical description of a line (Plücker, 1865; Brand, 1947). These are analogous to the four homogeneous coordinates used to represent a point (Maxwell, 1951).

The six Plücker coordinates arise as the components of two vectors (Figure 4). The first vector, \mathbf{L} , with three components, L , M and N , defines the direction of the given line. The second vector, \mathbf{L}_0 , with components, L_0 , M_0 and N_0 , is the moment of the line about the origin. So, $\mathbf{r} \times \mathbf{L} = \mathbf{L}_0$, where \mathbf{r} is the position vector of any point on the line. Now, it is clear from contemporary standard vector algebra (Gibbs, 1901; Brand, 1947) that $\mathbf{L} \cdot \mathbf{L}_0 = \mathbf{L}_0 \cdot \mathbf{L} = (\mathbf{r} \times \mathbf{L}) \cdot \mathbf{L} = 0$, and so the two vectors \mathbf{L} and \mathbf{L}_0 are always orthogonal. The six Plücker coordinates satisfy the relationship $\mathbf{L} \cdot \mathbf{L}_0 = LL_0 + MM_0 + NN_0 = 0$. Additionally, the vectors, $\mu\mathbf{L} = (\mu L, \mu M, \mu N)$ and $\mu\mathbf{L}_0 = (\mu L_0, \mu M_0, \mu N_0)$ for arbitrary non-zero μ , give the same line as before. It is usual to choose \mathbf{L} as a unit vector and hence to choose L , M and N such that $L^2 + M^2 + N^2 = 1$, so that they represent the direction cosines of the line. There are hence two conditions imposed on the six Plücker coordinates and only four independent coordinates remain, as expected for a line in 3D space.

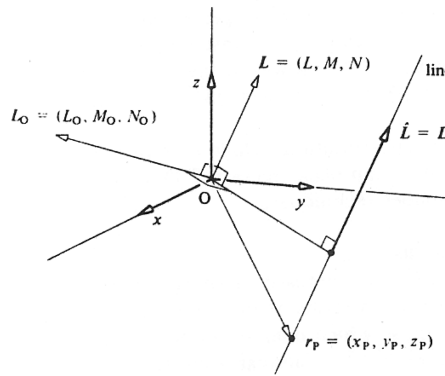

Fig. 4. The six Plücker coordinates $(L, M, N; L_0, M_0, N_0)$ of a straight line in 3D space, represented by a unit dual vector \hat{L} , where \mathbf{L} defines the direction of \hat{L} and \mathbf{L}_0 is the moment of \hat{L} about the origin. (Source: J. Rooney, 1978a, p. 46)

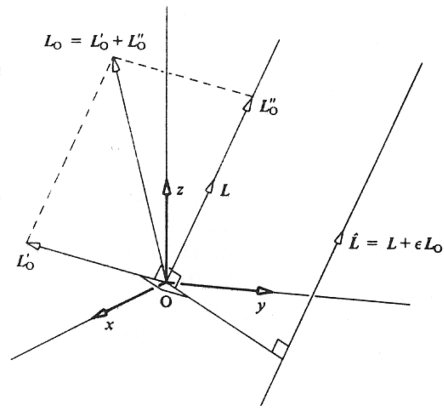

Fig. 5. A general dual vector \hat{L} (a motor), representing a screw in 3D space, where \mathbf{L} defines the magnitude and direction of \hat{L} , where \mathbf{L}'_0 is the moment of \hat{L} about the origin, and where $|\mathbf{L}'_0|/|\mathbf{L}|$ defines the pitch of the screw. (Source: J. Rooney, 1978a, p. 50)

If the line passes through the origin, its moment, \mathbf{L}_0 , is zero, it is specified by a single vector \mathbf{L} , and it has only two degrees of freedom. Lines through the origin may therefore be put into one-one correspondence with the points on the surface of a unit sphere centred on the origin, and this forms part of the basis of the relationship between spherical (2D curved) geometry and spatial (3D flat) geometry.

The new location of a specific point under a line transformation is obtained by operating separately on any *two lines* which intersect in the point at its initial position, and then determining their new point of intersection after the transformation. This is analogous to the method used to find the new location of a line under a point transformation. In this case the procedure is to transform any *two points* lying on the initial line and then to determine the line joining their new positions.

The six Plücker coordinates $(L, M, N; L_0, M_0, N_0)$ of a line, define the position and orientation of the line with respect to a point O, the origin. To describe the relative orientation of *two* directed skew straight lines in space a unique *twist angle*, α and a unique *common perpendicular distance*, d , are defined, although these two variables do not completely specify the configuration since the common perpendicular line itself must also be given. The

situation is analogous to the case of two intersecting lines (Rooney, 1977). There the lines define a unique angle at which they intersect, but the normal line to the plane in which they lie is needed for a complete specification of the relative orientation. It is advantageous to combine the two real variables (scalars), α and d , into a type of 'complex number', known as a *dual number*. It is not widely known that the usual complex number may be generalised, and there are a further two essentially different types (Yaglom, 1968). All three are considered in (Rooney, 1978b) in the context of geometry and kinematics. These are:

the *complex number* $a + ib$, where $i^2 = -1$

the *dual number* $a + \varepsilon b$, where $\varepsilon^2 = 0$

the *double number* $a + jb$, where $j^2 = +1$

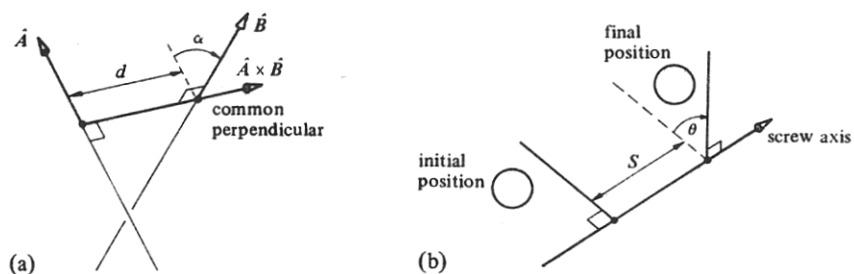

Fig. 6. Dual angles in 3D space: (a) the dual angle, $\alpha + \varepsilon d$, between two skew lines; (b) the dual angular displacement, $\theta + \varepsilon S$, of a rigid body. (Source: J. Rooney, 1978a, p. 47)

Algebraically, each of the three different types of complex number is just an ordered pair (a, b) of real numbers with a different multiplication rule for the product of two such ordered pairs. The symbol ε in the dual number is essentially the operator originally introduced by Clifford, (1873), although here it is an abstract algebraic quantity rather than an operator in mechanics. The usefulness of this type of abstract number derives from the work of (Study, 1901) who showed how the twist angle, α and common perpendicular distance, d , between two skew lines may be combined into a dual number of the form $\alpha + \varepsilon d$ (where $\varepsilon^2 = 0$). This is referred to as the *dual angle* between the lines (Figure 6a).

Dual angles also occur in the description of a general rigid-body spatial displacement, which involves a real angle and a real distance (Figure 6b).

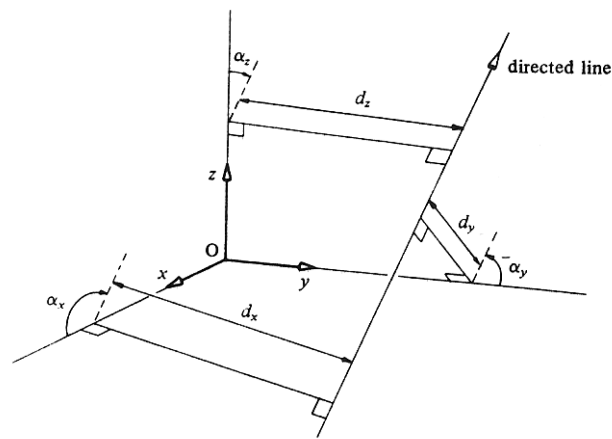

Fig. 7. The dual direction cosines, $\cos(\alpha_x + \varepsilon d_x)$, $\cos(\alpha_y + \varepsilon d_y)$, and $\cos(\alpha_z + \varepsilon d_z)$ of a directed line in space. (Source: J. Rooney, 1978a, p. 48)

It was Chasles (1830) who proved that such a displacement was equivalent to a combination of a *rotation* about and a *translation* along some straight line. Later Ball (1900) referred to this as a *screw displacement* about a *screw axis*. The motion thus defines a unique screw axis, a unique real angle θ (the rotation), and a unique real distance S (the translation). The variables θ and S may be combined into a dual number of the form $\theta + \varepsilon S$. This dual number is essentially a dual angle since the screw displacement may be specified by the initial and final positions of a line perpendicular to the screw axis, and these positions form a pair of skew lines (Figure 6b). Thus a spatial screw displacement can be considered to be a dual angular displacement about a general line (the screw axis) in space.

A given line in space, which does not pass through the origin, has three dual angles associated with it and they define it completely. These are the dual angles $\alpha_x + \varepsilon d_x$, $\alpha_y + \varepsilon d_y$, and $\alpha_z + \varepsilon d_z$, that it makes with the three coordinate axes (Figure 7). These three dual angles may be related to the six Plücker coordinates $(L, M, N; L_0, M_0, N_0)$, using rules for the expansion of (trigonometric) functions of a dual variable, and it is shown in Rooney (1978a) that the relationships are:

$$\begin{aligned} \cos(\alpha_x + \varepsilon d_x) &= L + \varepsilon L_0, \\ \cos(\alpha_y + \varepsilon d_y) &= M + \varepsilon M_0, \\ \cos(\alpha_z + \varepsilon d_z) &= N + \varepsilon N_0. \end{aligned}$$

The three dual numbers $L + \varepsilon L_0$, $M + \varepsilon M_0$ and $N + \varepsilon N_0$ are referred to as the *dual direction cosines* of the line and they may be considered to be the three components of a *unit dual vector*, $\hat{\mathbf{L}}$ in the same way that (L, M, N) forms a unit real vector, \mathbf{L} whose components are three real direction cosines. The dual vector describing any line in space is written:

$$\hat{\mathbf{L}} = \mathbf{L} + \varepsilon \mathbf{L}_0 = (L, M, N) + \varepsilon(L_0, M_0, N_0) = (L + \varepsilon L_0, M + \varepsilon M_0, N + \varepsilon N_0).$$

Here the circumflex over a quantity does not indicate a unit quantity. It is referred to as the *dual symbol* and it is used always to signify a dual quantity (a dual number, dual vector, dual matrix, or dual quaternion). Thus, $\alpha + \varepsilon d$ would be written as $\hat{\alpha}$, and $\theta + \varepsilon S$ as $\hat{\theta}$. Similarly \hat{L} would be $L + \varepsilon L_0$. The first component of the dual quantity (\mathbf{L} , α , θ , L , etc.) is referred to as the real or *primary* part and the second component (\mathbf{L}_0 , d , S , L_0 , etc.) is the dual or *secondary* part. Geometrically, the relationship between a real quantity, say α , and its corresponding dual quantity $\hat{\alpha}$ ($= \alpha + \varepsilon d$) is essentially the relationship between the geometry of intersecting lines (spherical geometry) and the geometry of skew lines (spatial geometry).

Spherical geometry is partly concerned with subsets of points on the surface of a unit sphere. For example, three great-circle arcs define a *spherical triangle* (Todhunter and Leathem, 1932). But, since any point on the surface defines a unique (radial) line joining it to the centre, O, of the sphere, spherical geometry is also concerned with sets of intersecting straight lines in space (Figure 8a). The two viewpoints are equivalent and the length of a great-circle arc on the surface corresponds to the angle between the two intersecting lines defining the arc's endpoints. Three intersecting lines determine a spherical triangle.

Spatial geometry is partly concerned with the more general situation of non-intersecting or skew straight lines in space. For example, three skew lines define a *spatial triangle* (Yang, 1963), and Figure 8b illustrates these lines and their three common perpendiculars. For spatial rotations about a fixed point, O, the rotation axes all intersect in O and the geometry is spherical (Rooney, 1977). For screw displacements about skew lines the geometry is spatial (Rooney, 1978a).

The relationship between spherical geometry and spatial geometry was formalised by Kotelnikov (1895) in his *Principle of Transference*. The original reference is very difficult to obtain and consequently the precise statement of the principle and its original proof are not generally avail-

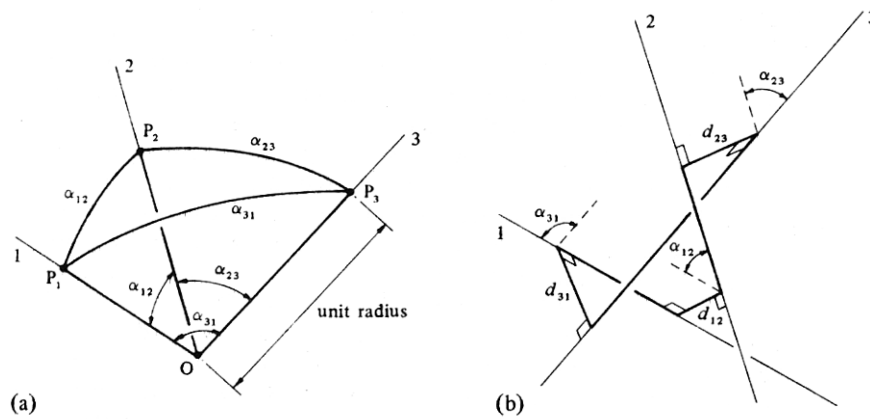

Fig. 8. The relationship between spherical geometry and spatial geometry: (a) a spherical triangle; (b) a spatial triangle. (Source: J. Rooney, 1978a, p. 51)

able (Rooney, 1975a). The one-many relationship may be expressed as $\alpha \leftrightarrow \alpha + \varepsilon d$ and $\theta \leftrightarrow \theta + \varepsilon S$. One version of the principle states that

all laws and formulae relating to a spherical configuration (involving intersecting lines and real angles) are also valid when applied to an equivalent spatial configuration of skew lines if each real angle, α or θ , in the spherical formulae is replaced by the corresponding dual angle, $\alpha + \varepsilon d$ or $\theta + \varepsilon S$.

The real direction cosines, L , M and N , of a line through the origin involve the real angles α_x , α_y , and α_z , and the dual direction cosines, $L + \varepsilon L_0$, $M + \varepsilon M_0$ and $N + \varepsilon N_0$, of a general line involve the dual angles $\alpha_x + \varepsilon d_x$, $\alpha_y + \varepsilon d_y$, and $\alpha_z + \varepsilon d_z$. Thus, in applying the principle, real angles and real direction cosines must be replaced with dual angles and dual direction cosines respectively.

The dual vector $\hat{\mathbf{L}} = \mathbf{L} + \varepsilon \mathbf{L}_0$ representing a line, as in Figure 4, not passing through the origin is not the most general type of dual vector that may occur since, in Figure 4, \mathbf{L} and \mathbf{L}_0 are orthogonal and \mathbf{L} is a unit vector, so there $\hat{\mathbf{L}} = \mathbf{L} + \varepsilon \mathbf{L}_0$ is a *unit dual vector*. In the general case \mathbf{L} need not be a unit vector and need not be orthogonal to \mathbf{L}_0 , which is then not the moment of $\hat{\mathbf{L}}$ about the origin. What is obtained is a dual vector with six independent real components (L , M , N , L_0 , M_0 and N_0), which is referred to as a *motor* (Clifford, 1873; Brand, 1947). This describes a line in space (as

before) but with two extra magnitudes. The situation is illustrated by Figure 5, and the two extra magnitudes are the magnitude of \mathbf{L} (this was previously a unit vector in Figure 4) and the component of \mathbf{L}_0 along \mathbf{L} , namely \mathbf{L}_0'' (this was previously zero in Figure 4). The direction of the line is still given by \mathbf{L} , and the component of \mathbf{L}_0 perpendicular to \mathbf{L} , namely \mathbf{L}_0' , now represents the moment of \mathbf{L} about the origin, O .

A dot product and a cross product may be defined for general dual vectors in the style of Gibbs (1901). Thus, given two dual vectors $\hat{\mathbf{A}}$ and $\hat{\mathbf{B}}$, where $\hat{\mathbf{A}} = \mathbf{A} + \varepsilon\mathbf{A}_0$ and $\hat{\mathbf{B}} = \mathbf{B} + \varepsilon\mathbf{B}_0$, the dot product, or *scalar product* (Brand, 1947), is defined as:

$$\hat{\mathbf{A}} \cdot \hat{\mathbf{B}} = (\mathbf{A} + \varepsilon\mathbf{A}_0) \cdot (\mathbf{B} + \varepsilon\mathbf{B}_0) = \mathbf{A} \cdot \mathbf{B} + \varepsilon(\mathbf{A} \cdot \mathbf{B}_0 + \mathbf{A}_0 \cdot \mathbf{B}).$$

This is a dual number in general and is independent of the location of O , the origin. It can be shown that if $\hat{\mathbf{A}}$ and $\hat{\mathbf{B}}$ are unit dual vectors defining two lines in space and if the dual angle between the lines is $\hat{\alpha} = \alpha + \varepsilon d$ then

$$\hat{\mathbf{A}} \cdot \hat{\mathbf{B}} = \cos \hat{\alpha} = \cos(\alpha + \varepsilon d) = \cos \alpha - \varepsilon d \sin \alpha.$$

This is in complete analogy with the relationship between two unit real vectors and the real angle between them: $\mathbf{A} \cdot \mathbf{B} = \cos \alpha$. If the scalar product of two non-parallel unit dual vectors is real (that is, if the dual part is zero) then the lines intersect. In addition if the scalar product is zero (that is, if both real and dual parts are zero) then the lines intersect at right angles (Brand, 1947).

In a similar way the cross product, or *motor product* (Brand, 1947) of two dual vectors in the style of Gibbs (1901) is defined as:

$$\hat{\mathbf{A}} \times \hat{\mathbf{B}} = (\mathbf{A} + \varepsilon\mathbf{A}_0) \times (\mathbf{B} + \varepsilon\mathbf{B}_0) = \mathbf{A} \times \mathbf{B} + \varepsilon(\mathbf{A} \times \mathbf{B}_0 + \mathbf{A}_0 \times \mathbf{B}).$$

This is a motor in general and the line it defines is the common perpendicular line to $\hat{\mathbf{A}}$ and $\hat{\mathbf{B}}$ (Figure 6a). If $\hat{\mathbf{E}} = \mathbf{E} + \varepsilon\mathbf{E}_0$ is a unit line vector representing this common perpendicular, if $\hat{\alpha} = \alpha + \varepsilon d$ is the dual angle between $\hat{\mathbf{A}}$ and $\hat{\mathbf{B}}$, and if $\hat{\mathbf{A}}$ and $\hat{\mathbf{B}}$ are unit dual vectors then it can be shown that

$$\hat{\mathbf{A}} \times \hat{\mathbf{B}} = \sin \hat{\alpha} \hat{\mathbf{E}} = (\sin \alpha + \varepsilon d \cos \alpha) \hat{\mathbf{E}}.$$

Again this is in complete analogy with the real vector case: $\mathbf{A} \times \mathbf{B} = \sin \alpha \mathbf{E}$. If the motor product of two unit dual vectors is a pure dual vector (that is, if the real or primary part is zero) then the lines are parallel. In addition if the dual part is also zero then the lines are collinear (Brand, 1947). Finally it

is possible to define scalar triple products and motor triple products for dual vectors in complete analogy with the usual real vector case.

Now, because the general spatial screw displacement (Figure 6b) of a rigid body consists of a rotation through an angle θ about and a translation through a distance S along an axis in space (Chasles, 1830; Ball, 1900), a total of six parameters are necessary to define the displacement completely. Four parameters specify the axis (a line in 3D space), one parameter specifies θ , and one parameter specifies S . It thus appears that a single finite screw displacement may be represented by a general dual vector or *motor* (Clifford, 1873; Brand, 1947) since two magnitudes (θ and S) and a line having both direction and position are involved.

However, although this relatively simple representation is possible, it is not a very satisfactory one. The disadvantages arise in attempting to obtain the resultant of two successive screw displacements (this should itself be a screw displacement). One problem is that two screw displacements do not commute and the order in which they occur must first be specified. The resultant motor cannot therefore just be given by the sum (which is commutative) of the two individual motors, as it should be, if the screw displacements behaved as true motors. This situation is analogous to that encountered in attempting to use a simple vector representation for the sum of two finite rotations about a fixed point (Rooney, 1977). In that case the parallelogram addition law fails to give the resultant of two such rotations. As a consequence it is not possible to use a simple motor representation for screw displacements. Instead, a line transformation is used for the representation (Rooney, 1978a). The line transformation (representing a screw) is derived from a point transformation (representing a rotation) by replacing real angles and real direction cosines with dual angles and dual direction cosines in accordance with the Principle of Transference. The line transformation approach leads to the modern equivalent of Clifford's biquaternion, namely the *unit dual quaternion* representation, involving a combination of quaternions and dual numbers. The unit dual quaternion derives from a unit quaternion by replacing the four real components of the latter with four dual number components. Alternatively two real quaternions are combined as the primary and secondary parts of the resulting unit dual quaternion.

The concept of a quaternion, as introduced and developed by Hamilton (1844, 1899, 1901), was invented to enable the ratio of two vectors to be defined and thus could be used to stretch-rotate one vector, \mathbf{r} , into another,

\mathbf{r}' , by premultiplying the first with a suitable quaternion. In this case \mathbf{r} would be premultiplied by the product $\mathbf{r}'\mathbf{r}^{-1}$. The latter ‘quotient’ of vectors is a quaternion if the inverse \mathbf{r}^{-1} of \mathbf{r} is given an appropriate definition. The operation of premultiplying \mathbf{r} by the quaternion $\mathbf{r}'\mathbf{r}^{-1}$ may be viewed as a point transformation operating on the point represented by the position vector \mathbf{r} .

The equivalent operation for line transformations requires an operator capable of operating on a line, and screw displacing it. A point transformation operates on the position vector, \mathbf{r} , of a point to give another position vector, \mathbf{r}' . A line is represented by a unit dual vector $\hat{\mathbf{L}} = \mathbf{L} + \varepsilon\mathbf{L}_0$, where $\mathbf{L} \cdot \mathbf{L} = 1$, and $\mathbf{L} \cdot \mathbf{L}_0 = 0$, so by analogy the problem is essentially one of transforming one unit dual vector $\hat{\mathbf{L}}_1$ into another, $\hat{\mathbf{L}}_2$. As with the quaternion ratio of two vectors, $\mathbf{r}'\mathbf{r}^{-1}$, this may be achieved if an appropriate ratio or quotient $\hat{\mathbf{B}}\hat{\mathbf{A}}^{-1}$ of two general dual vectors $\hat{\mathbf{A}}$ and $\hat{\mathbf{B}}$ can be defined. It was an analogous problem that led Clifford to invent the biquaternion as the ratio of two motors (Clifford, 1873). It transpires that the ratio of two general dual vectors is an operator formed from a combination of a quaternion and a dual number. Nowadays this is referred to as a *unit dual quaternion*, although it is essentially a biquaternion.

The relative spatial relationship of two general dual vectors $\hat{\mathbf{A}}$ and $\hat{\mathbf{B}}$ requires eight parameters for its specification. Four of these define the common perpendicular line between the axes of the motors; two more specify the dual angle between these axes; and finally two parameters are required to represent the ratios of the two magnitudes associated with the second motor to those associated with the first. So an operator to transform $\hat{\mathbf{A}}$ into $\hat{\mathbf{B}}$ must also have at least eight parameters in its specification.

A dual quaternion \hat{q} is a 4-tuple of dual numbers of the form $\hat{q} = (q_1 + \varepsilon q_{01}, q_2 + \varepsilon q_{02}, q_3 + \varepsilon q_{03}, q_4 + \varepsilon q_{04})$, where $\varepsilon^2 = 0$, and hence it has eight real components, $q_1, q_2, q_3, q_4, q_{01}, q_{02}, q_{03}$ and q_{04} . It may be written alternatively, as with all dual quantities, in terms of primary and secondary parts as

$$\hat{q} = (q_1, q_2, q_3, q_4) + \varepsilon(q_{01}, q_{02}, q_{03}, q_{04}) = q + \varepsilon q_0,$$

where q and q_0 are real quaternions. This looks just like Clifford’s biquaternion $q + \omega r$ where $\omega^2 = 0$. The operator for screw displacement is formed from a dual quaternion by providing the latter with an appropriate consistent algebra.

An algebra is imposed on dual quaternions by defining a suitable multiplication rule (addition and subtraction are performed componentwise). The rule that corresponds with that of Clifford (1873), for his biquaternions, is essentially equivalent to that for the real quaternions (Hamilton, 1844, 1899, 1901; Rooney, 1977) but with each real component replaced by the corresponding dual component. So, write two dual quaternions, \hat{p} and \hat{q} , in the form

$$\begin{aligned}\hat{p} &= (p_1 + \varepsilon p_{01}) + (p_2 + \varepsilon p_{02})i + (p_3 + \varepsilon p_{03})j + (p_4 + \varepsilon p_{04})k, \\ \hat{q} &= (q_1 + \varepsilon q_{01}) + (q_2 + \varepsilon q_{02})i + (q_3 + \varepsilon q_{03})j + (q_4 + \varepsilon q_{04})k.\end{aligned}$$

Then the dual quaternion product of \hat{p} and \hat{q} is defined by expanding the expression $\hat{p}\hat{q}$ using the standard rules of algebra together with the multiplication rules for products of quaternions, $i^2 = j^2 = k^2 = ijk = -1$ and $ij = k = -ji$, $jk = i = -kj$, $ki = j = -ik$, and finally using the rule $\varepsilon^2 = 0$, to give:

$$\begin{aligned}\hat{p}\hat{q} &= [(p_1q_1 - p_2q_2 - p_3q_3 - p_4q_4) \\ &\quad + \varepsilon(p_1q_{01} - p_2q_{02} - p_3q_{03} - p_4q_{04} + p_{01}q_1 - p_{02}q_2 - p_{03}q_3 - p_{04}q_4)] \\ &\quad + [(p_1q_2 + p_2q_1 + p_3q_4 - p_4q_3) \\ &\quad + \varepsilon(p_1q_{02} + p_2q_{01} + p_3q_{04} - p_4q_{03} + p_{01}q_2 + p_{02}q_1 + p_{03}q_4 - p_{04}q_3)]i \\ &\quad + [(p_1q_3 - p_2q_4 + p_3q_1 + p_4q_2) \\ &\quad + \varepsilon(p_1q_{03} - p_2q_{04} + p_3q_{01} + p_4q_{02} + p_{01}q_3 - p_{02}q_4 + p_{03}q_1 + p_{04}q_2)]j \\ &\quad + [(p_1q_4 + p_2q_3 - p_3q_2 + p_4q_1) \\ &\quad + \varepsilon(p_1q_{04} + p_2q_{03} - p_3q_{02} + p_4q_{01} + p_{01}q_4 + p_{02}q_3 - p_{03}q_2 + p_{04}q_1)]k.\end{aligned}$$

Division is defined (as an inverse of multiplication) for dual quaternions in terms of a *conjugate* and a *norm*. This is analogous to the division process for quaternions. The conjugate of \hat{q} is defined as

$$\overline{\hat{q}} = (q_1 + \varepsilon q_{01}) - (q_2 + \varepsilon q_{02})i - (q_3 + \varepsilon q_{03})j - (q_4 + \varepsilon q_{04})k$$

and the norm of \hat{q} is defined as the dual number

$$\begin{aligned}|\hat{q}| &= (q_1 + \varepsilon q_{01})^2 + (q_2 + \varepsilon q_{02})^2 + (q_3 + \varepsilon q_{03})^2 + (q_4 + \varepsilon q_{04})^2 \\ &= (q_1^2 + q_2^2 + q_3^2 + q_4^2) + 2\varepsilon(q_1q_{01} + q_2q_{02} + q_3q_{03} + q_4q_{04}).\end{aligned}$$

The *inverse* or *reciprocal* of \hat{q} is then

$$\hat{q}^{-1} = \frac{\overline{\hat{q}}}{|\hat{q}|}.$$

This is not defined if the primary part, q , of \hat{q} is zero (that is, if $q_1 = q_2 = q_3 = q_4 = 0$) since the norm is then zero. It is easily checked that, for a non-zero norm, $\hat{q}\hat{q}^{-1} = \hat{q}^{-1}\hat{q} = 1$. If $|\hat{q}| = 1$ the dual quaternion is a unit dual quaternion.

In complete analogy with the real quaternions and real vectors considered in Rooney (1977), it is possible to use a dual quaternion to provide a dual vector algebra (Brand, 1947; Yang, 1963; Rooney, 1977). Thus a dual vector is identified with a dual quaternion having a zero first (dual number) component. Given two such dual vectors

$$\begin{aligned}\hat{\mathbf{A}} &= (A_1 + \varepsilon A_{01})i + (A_2 + \varepsilon A_{02})j + (A_3 + \varepsilon A_{03})k, \\ \hat{\mathbf{B}} &= (B_1 + \varepsilon B_{01})i + (B_2 + \varepsilon B_{02})j + (B_3 + \varepsilon B_{03})k,\end{aligned}$$

their dual quaternion product is

$$\begin{aligned}\hat{\mathbf{A}}\hat{\mathbf{B}} &= -[(A_1 + \varepsilon A_{01})(B_1 + \varepsilon B_{01}) \\ &\quad + (A_2 + \varepsilon A_{02})(B_2 + \varepsilon B_{02}) + (A_3 + \varepsilon A_{03})(B_3 + \varepsilon B_{03})] \\ &\quad + [(A_2 + \varepsilon A_{02})(B_3 + \varepsilon B_{03}) - (A_3 + \varepsilon A_{03})(B_2 + \varepsilon B_{02})]i \\ &\quad + [(A_3 + \varepsilon A_{03})(B_1 + \varepsilon B_{01}) - (A_1 + \varepsilon A_{01})(B_3 + \varepsilon B_{03})]j \\ &\quad + [(A_1 + \varepsilon A_{01})(B_2 + \varepsilon B_{02}) - (A_2 + \varepsilon A_{02})(B_1 + \varepsilon B_{01})]k.\end{aligned}$$

This is expressed more concisely in terms of the scalar and motor products already defined earlier for dual vectors (Brand, 1947). It is then easily shown that the dual quaternion product of $\hat{\mathbf{A}}$ and $\hat{\mathbf{B}}$ is

$$\hat{\mathbf{A}}\hat{\mathbf{B}} = -\hat{\mathbf{A}} \cdot \hat{\mathbf{B}} + \hat{\mathbf{A}} \times \hat{\mathbf{B}}.$$

This product is in general a dual quaternion since the first component (the scalar product) is non-zero unless the lines associated with $\hat{\mathbf{A}}$ and $\hat{\mathbf{B}}$ intersect at right angles.

The ‘ratio’ of any two dual vectors $\hat{\mathbf{B}}$ and $\hat{\mathbf{A}}$ can now be formed as

$$\hat{\mathbf{B}}\hat{\mathbf{A}}^{-1} = -\frac{\hat{\mathbf{B}}\hat{\mathbf{A}}}{|\hat{\mathbf{A}}|},$$

where $\hat{\mathbf{A}}^{-1}$ is the (dual quaternion) inverse of $\hat{\mathbf{A}}$. This product $\hat{\mathbf{B}}\hat{\mathbf{A}}^{-1}$ is a dual quaternion and it will operate on the dual vector $\hat{\mathbf{A}}$ to give the dual vector $\hat{\mathbf{B}}$ since $(\hat{\mathbf{B}}\hat{\mathbf{A}}^{-1})\hat{\mathbf{A}} = \hat{\mathbf{B}}$. It is the modern form of Clifford's biquaternion. There are of course two ratios since dual quaternions do not commute, and it is equally possible to consider the 'ratio' $\hat{\mathbf{A}}^{-1}\hat{\mathbf{B}}$ in the above.

The operator $\hat{\mathbf{B}}\hat{\mathbf{A}}^{-1}$ operates on $\hat{\mathbf{A}}$ to produce $\hat{\mathbf{B}}$. But an operation is required which will screw displace *any* dual vector along a given line, and not just those intersecting the line orthogonally. For this reason, and by use of arguments similar to those considered in Rooney (1977), the following type of three-term product operation is needed to operate on any dual vector $\hat{\mathbf{A}}$ to screw displace it into $\hat{\mathbf{A}}'$:

$$\hat{\mathbf{A}}' = \hat{q}_{\hat{\mathbf{n}}}^{-1}(\hat{\theta})\hat{\mathbf{A}}\hat{q}_{\hat{\mathbf{n}}}(\hat{\theta}).$$

Here

$$\hat{q}_{\hat{\mathbf{n}}}(\hat{\theta}) = \cos \frac{\hat{\theta}}{2} + \sin \frac{\hat{\theta}}{2} \hat{\mathbf{n}}$$

is a unit dual quaternion, and $\hat{q}_{\hat{\mathbf{n}}}^{-1}(\hat{\theta})$ is its inverse (equal to its conjugate since its norm is unity). The dual angle $\hat{\theta} = \theta + \varepsilon S$ combines the screw displacement angle θ , and distance S , along the screw axis $\hat{\mathbf{n}}$, where

$$\hat{\mathbf{n}} = (l + \varepsilon l_0)i + (m + \varepsilon m_0)j + (n + \varepsilon n_0)k$$

represents the line of the screw axis, with direction cosines (l, m, n) and moment (l_0, m_0, n_0) about the origin, and where

$$(l + \varepsilon l_0)^2 + (m + \varepsilon m_0)^2 + (n + \varepsilon n_0)^2 = 1.$$

The trigonometric functions of the dual variable $\hat{\theta}$ are evaluated using the rules for expanding functions of a dual variable, namely:

$$\cos(\theta + \varepsilon S) = \cos \theta - \varepsilon S \sin \theta,$$

$$\sin(\theta + \varepsilon S) = \sin \theta + \varepsilon S \cos \theta.$$

The above operation, $\hat{\mathbf{A}}' = \hat{q}_{\hat{\mathbf{n}}}^{-1}(\hat{\theta})\hat{\mathbf{A}}\hat{q}_{\hat{\mathbf{n}}}(\hat{\theta})$, achieves the desired general screw transformation of any $\hat{\mathbf{A}}$ into a new position $\hat{\mathbf{A}}'$. It is equivalent to Clifford's

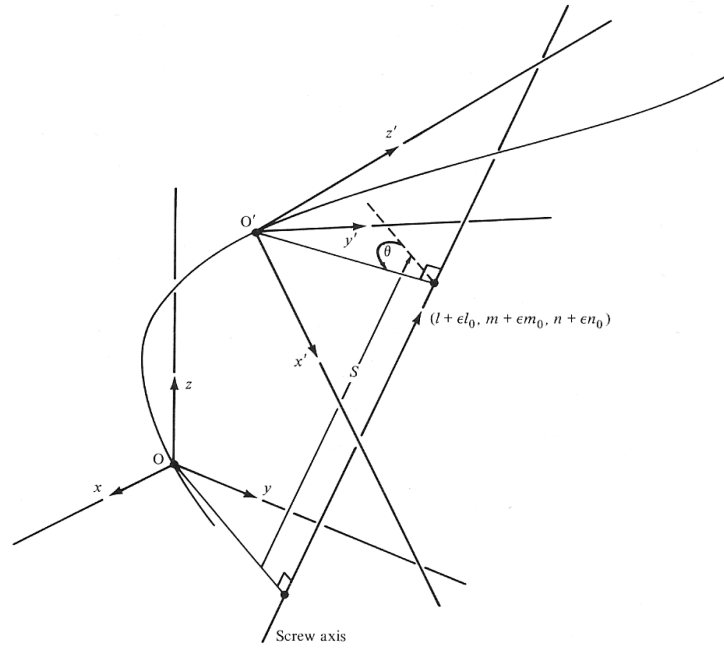

Fig. 9. The general spatial screw displacement of a coordinate system about a screw axis through angle θ and distance S . (Source: J. Rooney, 1984, p. 237)

tensor-twist, since it does not change the pitch of $\hat{\mathbf{A}}$. Although the operation is expressed in terms of the half dual angle

$$\frac{\hat{\theta}}{2} = \frac{\theta}{2} + \varepsilon \frac{S}{2},$$

it actually screw transforms $\hat{\mathbf{A}}$ into $\hat{\mathbf{A}}'$ through the full dual angle $\hat{\theta} = \theta + \varepsilon S$. The necessity for introducing the half dual angle into the unit dual quaternion echoes the situation that occurs with the representation of rotations about a fixed point using unit quaternions (Rooney, 1977). It was Rodrigues (1840) who first recognised this need when several rotations are performed consecutively (Baker and Parkin, 2003). It transfers naturally into the screw displacement situation. Because of the half dual angle the representation is double valued since $\hat{q}_{\hat{\mathbf{n}}}(\hat{\theta} + 2\pi) = -\hat{q}_{\hat{\mathbf{n}}}(\hat{\theta})$.

The form of the unit dual quaternion $\hat{q}_{\hat{\mathbf{n}}}(\hat{\theta})$ representing a general screw displacement of the xyz Cartesian coordinate system about a line with dir-

ection cosines (l, m, n) and moment (l_0, m_0, n_0) about the origin, through an angle θ and a distance S (see Figure 9), is expanded as:

$$\begin{aligned}
 \hat{q}_{\hat{\mathbf{n}}}(\hat{\theta}) &= \cos \frac{\hat{\theta}}{2} + \sin \frac{\hat{\theta}}{2} \hat{\mathbf{n}} \\
 &= \cos \frac{\theta + \varepsilon S}{2} + \sin \frac{\theta + \varepsilon S}{2} [(l + \varepsilon l_0)i + (m + \varepsilon m_0)j + (n + \varepsilon n_0)k] \\
 &= \left[\cos \frac{\theta}{2} - \varepsilon \frac{S}{2} \sin \frac{\theta}{2} \right] \\
 &\quad + \left[l \sin \frac{\theta}{2} + \varepsilon \left(l \frac{S}{2} \cos \frac{\theta}{2} + l_0 \sin \frac{\theta}{2} \right) \right] i \\
 &\quad + \left[m \sin \frac{\theta}{2} + \varepsilon \left(m \frac{S}{2} \cos \frac{\theta}{2} + m_0 \sin \frac{\theta}{2} \right) \right] j \\
 &\quad + \left[n \sin \frac{\theta}{2} + \varepsilon \left(n \frac{S}{2} \cos \frac{\theta}{2} + n_0 \sin \frac{\theta}{2} \right) \right] k.
 \end{aligned}$$

A unit dual quaternion $\hat{q}_{\hat{\mathbf{n}}}(\hat{\theta})$ is specified by only six (rather than eight) independent parameters because it has a unit norm, and so the operation $\hat{\mathbf{A}}' = \hat{q}_{\hat{\mathbf{n}}}^{-1}(\hat{\theta})\hat{\mathbf{A}}\hat{q}_{\hat{\mathbf{n}}}(\hat{\theta})$ screw transforms the dual vector $\hat{\mathbf{A}}$ without stretching it (its two magnitudes remain unchanged). It also transforms unit dual vectors $\hat{\mathbf{L}}$ into unit dual vectors.

The unit dual quaternion representation (the modern equivalent of Clifford's biquaternion, specifically his tensor-twist) for a screw displacement is elegant and economical compared with other representations. It is particularly useful when performing multiple screw displacements in succession, as is frequently required in the field of Mechanism and Machine Science. The representation is of course double-valued, so care must be taken in its use. It is considered to be one of the best representations of line transformations since it is so concise and is perhaps the most easily visualised of all the screw representations because the screw axis, $\hat{\mathbf{n}}$, and the dual angular displacement, $\theta + \varepsilon S$, enter so directly into its specification.

References

- Altmann, S.L. (1986), *Rotations, Quaternions, and Double Groups*, Clarendon Press, Oxford, ISBN 0198553722.
- Baker, E.J. and Parkin, I.A. (2003), *Fundamentals of Screw Motion* (English translation of seminal papers by M. Chasles and O. Rodrigues), School of Information Technologies, The University of Sydney, Australia.
- Baker, E.J. and Wohlhart, K. (1996), *Motor Calculus: A New Theoretical Device for Mechanics* (English translation of two papers by R. von Mises), The Institute of Mechanics, University of Technology, Graz, Austria.
- Ball, R.S. (1900), *A Treatise on the Theory of Screws*, Cambridge University Press, Cambridge.
- Brand, L. (1947), *Vector and Tensor Analysis*, John Wiley, New York.
- Chasles, M. (1830), Note sur les propriétés générales du système de deux corps semblables entr'eux et placés d'une manière quelconque dans l'espace; et sur le déplacement fini ou infiniment petit d'un corps solide libre, *Bulletin des Sciences Mathématiques, Astronomiques, Physiques et Chimiques de Férussac* **14**, 321–326.
- Chisholm, M. (2002), *Such Silver Currents – The Story of William and Lucy Clifford, 1845–1929*, Lutterworth Press, Cambridge, ISBN 0718830172.
- Clifford, W.K. (1873), Preliminary sketch of biquaternions, *Proceedings of the London Mathematical Society* **4**(64, 65), 381–395.
- Clifford, W.K. (1876a), Applications of Grassmann's Extensive Algebra, *American Journal of Mathematics, Pure and Applied* **1**, 350–358.
- Clifford, W.K. (1876b), Abstract of "On the Classification of Geometric Algebras", *Proceedings of the London Mathematical Society* **7**, 135 [Abstract communicated 10 March 1876; Unfinished paper found amongst Clifford's manuscripts].
- Clifford, W.K. (1877), *The Ethics of Belief*, Reprinted 1999, Prometheus Books, Amherst, ISBN 1573926914.
- Clifford, W.K. (1882), *Mathematical Papers* (Ed. R. Tucker), Reprinted 1968, Chelsea Publishing Company, New York.
- Conway, J.H. and Smith, D.A. (2003), *On Quaternions and Octonions*, A.K. Peters, Natick, MA, ISBN 1568811349.
- Davidson, J.K. and Hunt, K.H. (2004), *Robots and Screw Theory*, Oxford University Press, Oxford, ISBN 0198562454.
- Denavit, J. (1958), Displacement analysis of mechanisms based on (2×2) matrices of dual numbers, *VDI Berichte* **29**, 81–89.
- Dickson, L.E. (1923), *Algebras and Their Arithmetics*, Constable, London (Reprinted 1960, Dover Publications, New York).
- Dickson, L.E. (1930), *Linear Algebras*, Cambridge University Press, Cambridge.
- Dimentberg, F.M. (1965), The screw calculus and its applications in mechanics (Izdatel'stvo Nauka, Moscow) (English translation, 1968, AD680993, Foreign Technology Division WP-AFB, Ohio, USA).
- Gibbs, J.W. (1901), *Vector Analysis*, Yale University Press, New Haven, CT.
- Grassmann, H. (1844), *A New Branch of Mathematics: The Ausdehnungslehre of 1844*, Reprinted 1994, Open Court Publishing Co., ISBN 0812692764.

- Hamilton, W.R. (1844), On quaternions; or on a new system of imaginaries in algebra, *Philosophical Magazine Series 3* **25**, 489–495.
- Hamilton, W.R. (1899, 1901), *Elements of Quaternions*, 2 Vols., Cambridge University Press, Cambridge.
- Hestenes, D. (1986), *New Foundations for Classical Mechanics*, Kluwer Academic Publishers, Dordrecht, ISBN 0792355148.
- Hestenes, D. and Sobczyk, G. (1987), *Clifford Algebra to Geometric Calculus: A Unified Language for Mathematics and Physics*, Kluwer Academic Publishers, Dordrecht, ISBN 9027725616.
- Hunt, K.H. (1978), *Kinematic Geometry of Mechanisms*, Clarendon Press, Oxford, ISBN 0198561245.
- Keler, M. (1958), *Analyse und Synthese der Raumkurbelgetriebe mittels Raumliniengeometrie und dualer Größen*, PhD Dissertation, München.
- Kotelnikov, A.P. (1895), Screw calculus and some applications to geometry and mechanics, *Annals of the Imperial University of Kazan*.
- Kuipers, J.B. (1999), *Quaternions and Rotation Sequences: A Primer with Applications to Orbits, Aerospace and Virtual Reality*, Princeton University Press, Princeton, NJ.
- Maxwell, E.A. (1951), *General Homogeneous Co-ordinates in Space of Three Dimensions*, Cambridge University Press, Cambridge.
- Penrose, R. (2004), *The Road to Reality*, Jonathan Cape, London, ISBN 0224044478.
- Plücker, J. (1865), On a new geometry of space, *Philosophical Transactions* **155**, 724–791.
- Poinsot, L. (1806), Sur la composition des moments et la composition des aires, *Journal École Polytechnique, Paris* **6**, 182–205.
- Porteous, I.R. (1969), *Topological Geometry*, Van Nostrand Reinhold, New York (Second Edition, 1981, Cambridge University Press, Cambridge), ISBN 0521298393.
- Rodrigues, O. (1840), Des lois géométriques qui régissent les déplacements d'un système solide dans l'espace, et la variation des coordonnées provenant de ses déplacements considérés indépendamment des causes qui peuvent les produire, *Journal de Mathématiques Pures et Appliquées de Liouville* **5**, 380–440.
- Rogers, D.F. and Adams, J.A. (1976), *Mathematical Elements for Computer Graphics*, McGraw-Hill, New York.
- Rooney, J. (1974), *A Unified Theory for the Analysis of Spatial Mechanisms Based on Spherical Trigonometry*, PhD Thesis, Liverpool.
- Rooney, J. (1975a), On the principle of transference, in *Proceedings of the Fourth World Congress on the Theory of Machines and Mechanisms*, Newcastle-upon-Tyne, England, September 1975, J.N. Fawcett (Ed.), Institution of Mechanical Engineers, London, pp. 1088–1092.
- Rooney, J. (1975b), On obtaining the velocity motor of any link in a general n-link spatial manipulator, in *Proceedings of the Fourth World Congress on the Theory of Machines and Mechanisms*, Newcastle-upon-Tyne, England, September 1975, J.N. Fawcett (Ed.), Institution of Mechanical Engineers, London, pp. 1083–1087.
- Rooney, J. (1977), A survey of representations of spatial rotation about a fixed point, *Environment and Planning B* **4**, 185–210.
- Rooney, J. (1978a), 'A comparison of representations of general spatial screw displacement, *Environment and Planning B* **5**, 45–88.

- Rooney, J. (1978b), On the three types of complex number and planar transformations, *Environment and Planning B* **5**, 89–99.
- Rooney, J. (1984), Kinematic and geometric structure in robot systems, in *Artificial Intelligence: Tools, Techniques, and Applications*, T. O’Shea and M. Eisenstadt (Eds.), Harper & Row, New York, Chapter 8.
- Rooney, J. (2007), Multivectors and quaternions in rigid body rotation: Clifford vs Hamilton, in *Proceedings of the Twelfth World Congress on Mechanism and Machine Science*, Besançon, France, June 2007, to be published.
- Rooney, J. and Tanev, T.K. (2003), Contortion and formation structures in the mappings between robotic jointspaces and workspaces, *Journal of Robotic Systems* **20**(7), 341–353.
- Semple, J.G. and Roth, L. (1949), *An Introduction to Algebraic Geometry*, Clarendon Press, Oxford.
- Study, E. (1901), *Geometrie der Dynamen*, Teubner Verlag, Leipzig.
- Todhunter, I. and Leathem, J.G. (1932), *Spherical Trigonometry*, Macmillan, London.
- Von Mises, R. (1924a), Motorrechnung, ein neues Hilfsmittel in der Mechanik, *Zeitschrift für Angewandte Mathematik und Mechanik* **4**(2), 155–181.
- Von Mises, R. (1924b), Anwendungen der Motorrechnung, *Zeitschrift für Angewandte Mathematik und Mechanik* **4**(3), 193–213.
- Yaglom, I.M. (1968), *Complex Numbers in Geometry*, Academic Press, New York.
- Yang, A.T. (1963), Application of quaternion algebra and dual numbers to the analysis of spatial mechanisms, Doctoral Dissertation, Columbia University, Morningside Heights, NY.
- Yang, A.T. (1969), Displacement analysis of spatial five-link mechanisms using (3×3) matrices with dual-number elements, *Transactions of the American Society of Mechanical Engineers, Series B, Journal of Engineering for Industry* **91**, 152–157.
- Yang, A.T. and Freudenstein, F. (1964), Application of dual-number quaternion algebra to the analysis of spatial mechanisms, *Transactions of the American Society of Mechanical Engineers, Series E, Journal of Applied Mechanics* **31**, 300–308.
- Yuan, M.S.C. (1970), Kinematic analysis of spatial mechanisms by means of screw coordinates, Doctoral Dissertation, Columbia University, Morningside Heights, NY.
- Yuan, M.S.C. and Freudenstein, F. (1971), Kinematic analysis of spatial mechanisms by means of screw co-ordinates. Part 1: Screw co-ordinates, *Transactions of the American Society of Mechanical Engineers, Series B, Journal of Engineering for Industry* **93**, 61–66.